

SANUPS A11G-Ni

A11GN102

A11GN152

200V Type

Instruction Manual

SANYO DENKI

Introduction

Thank you for choosing the SANUPS (A11G-Ni).

SAVE THESE INSTRUCTIONS

This manual contains important instructions for A11G-Ni that should be followed during installation and maintenance of the UPS and batteries.

To use the UPS correctly and safely, read this manual before using the UPS.

After reading, please keep it handy for convenient reference.

This UPS is intended for installation in a temperature-controlled indoor environment free of conductive contaminants.

- Operating temperature: 0 to 40°C (32 to 104° F)

UPS is an abbreviation for Uninterruptible Power Supply.

Table of contents

1. Safety Precautions	1
2. Considerations for Proper Operation	5
2.1 Input Power Considerations.....	5
2.2 Installation Considerations.....	5
2.3 Usage Considerations	5
2.4 In Case of Trouble with the UPS	6
3. Confirming Package Contents.....	6
4. Overview.....	7
5. External Dimensions and Part Names.....	8
5.1 Overall Unit.....	8
5.2 Control Panel, Indicators.....	9
6. Carrying and Installation	10
6.1 Environment	10
6.2 Carrying	10
6.3 Installation Space	10
6.4 Support Bracket Installation.....	11
6.5 Plastic Hole Plug Installation.....	11
7. Wiring	12
7.1 UPS Wiring.....	12
7.2 Load Device Connections.....	13
7.3 External Control Signals	14
8 . Preparations Before Operation.....	16
9. Operation.....	17
9.1 Starting Operation (Normal Start)	17
9.2 Starting Operation (Battery Start)	18
9.3 Power Outage Simulation Test.....	20
9.4 Operation Shutdown (Daily)	21
9.5 Operation Shutdown (If UPS is not to be used for a week or more).....	21

10. Operating and Protective Functions	22
10.1 Basic Operation.....	22
10.2 Protective Functions	23
10.3 Protective Function Chart	24
11. Maintenance and Inspection.....	25
11.1 Daily Inspection	25
11.2 Battery Inspection.....	25
12. Special Functions	26
12.1 Battery Test.....	26
12.2 User Settings.....	27
12.2.1 OUTPUT 1 and 2 Timer Control Settings.....	28
12.2.2 Power Outage Beeper Setting.....	29
12.2.3 Output Frequency Range Setting.....	29
12.2.4 OUTPUT 0 Operation After OUTPUT 1 and 2 Shutdown During Power Outage.....	29
12.2.5 PC Interface Selection.....	30
12.2.6 Communications Baud Rate Selection.....	30
12.2.7 Ring Signal Start Setting.....	30
12.2.8 Battery Starting Frequency.....	30
13. Specifications.....	31
14. Warranty Conditions.....	32

1. Safety Precautions

PRECAUTIONS (IMPORTANT SAFETY INSTRUCTIONS)

Before installing, operating, performing maintenance or inspecting the UPS, be sure to read this manual and accompanying documents carefully to obtain a clear understanding of the information related to its operation, safety and important precautions.

This manual described two warning levels, DANGER and CAUTION, as described below.



Denotes immediate hazards which WILL probably cause severe bodily injury or death, as a result incorrect operation.



Denotes hazards which COULD cause bodily injury and product or property damage, as a result incorrect operation.

Additionally, even those hazards denoted by  could lead to a serious accident, so the instructions should be strictly followed.

The following labels indicate particularly important instructions which must be carefully followed. The graphic symbols indicate prohibited and mandatory actions.



Indicates actions that must not be allowed to occur (prohibited actions).



Indicates actions that must be taken (mandatory actions).

This example signifies that the equipment must be securely grounded.

1. Installation Precautions





CAUTION

- The UPS should be installed only by technically qualified personnel. Improper installation can result in electric shock, bodily injury, and/or fire.
- Never operate or store the UPS in the following environmental conditions. Doing so may cause the UPS to malfunction, sustain damage or deteriorate, which could result in a fire.
 - a. In ambient environmental conditions other than those specified in the product brochure and instruction manual (temperature 0 to 40°C (32 to 104° F), relative humidity 30 to 90%), such as in extremely high or low temperature and high humidity.
 - b. Where the UPS is exposed to direct sunlight.
 - c. Where the UPS is directly exposed to the heat from a heat source, such as a stove.
 - d. Where the UPS may be subject to vibration or physical shock.
 - e. Near a device that may emit sparks.
 - f. In the presence of dust, salt spray or corrosive or flammable gas.
 - g. Outdoors
- Do not allow the air intake or exhaust vents to be obstructed. Keep the front and back of the UPS at least 20 cm (7.9 in) away from the wall. If the air intake or exhaust vent is blocked, the internal temperature of the UPS rises, which could cause battery deterioration resulting in a fire. For maintenance, the UPS requires at least 1 m (39.4in) space at the front.
- The space around the UPS must be ventilated. Unless the specified ventilation airflow (5 m³/h) is maintained, gas produced by battery charging could result in rupture or explosion of the case.
- Install the UPS on a stable surface capable of bearing the weight of the UPS in the correct manner specified in this manual. A11GN102 weights about 19kg(41.9lbs), and A11GN152 weights about 24kg (52.9lbs). If the UPS is installed incorrectly, impact or vibration could cause it to fall or move inadvertently, resulting in bodily injury. Be careful to avoid back strain.
- Risk of electric shock, do not remove cover. No user serviceable parts inside. Refer servicing to qualified service personnel.

2. Wiring Precautions



CAUTION

- Wiring should be performed only by technically qualified personnel. Incorrect wiring can result in electric shock and/or fire.
- Connect the grounding cable securely in the manner specified (Input plug). Failure to connect the grounding cable may result in electric shock. 
- The grounding cables of all load devices* connected to the output of the UPS must be securely connected to the grounding terminal. Failure to connect the grounding cables correctly may result in electric shock. 

* Load devices are devices such as computers that are connected to the UPS.

3. Operating Precautions



DANGER

- Immediately shut the UPS off if it malfunctions, or if an unusual odor or noise is observed. Failure to do so may result in a fire.
- To avoid electric shock, do not open the cover of the UPS.



CAUTION

- The space around the UPS must be well ventilated. Otherwise, gas produced by battery charging could result in rupture or explosion of the case.
- Before starting the UPS, make sure that the load side is safe. Be sure to refer to the instruction manual while operating the UPS. The operating state of the UPS, as determined by the **INV. ON/STAND BY** switch and the **MAIN SW** switch, is indicated by the LEDs as shown the table below. Check these indicators when operating. Be careful when operating the **INV. ON/STAND BY** switch and the **MAIN SW** switch. If power is supplied incorrectly, an electric shock or bodily injury could result.

UPS Status		Power Output Status			LEDs	
MAIN SW	INV.ON/STAND BY	OUTPUT0	OUTPUT1	OUTPUT2		
OFF	STAND BY	Stopped	Stopped	Stopped	INPUT (off-green),	OUTPUT 0 (off-green)
ON	STAND BY	Feeding *1	Stopped	Stopped	INPUT (on-green),	OUTPUT 0 (blinking-green)
OFF	ON	Feeding *2	depends on the setting		INPUT (blinking-green),	OUTPUT 0 (on-green)
ON	ON	Feeding *2	depends on the setting		INPUT (on-green),	OUTPUT 0 (on-green)

*1: Power supplied from bypass circuit, *2:Power supplied from inverter

- Avoid inserting sharp objects or fingers into the fan. Doing so may result in bodily injury.



PROHIBITED

- Never use the UPS for the following types of loads:
 - a. Medical instruments used for life support.
 - b. Control units for trains or elevators, failure of which could cause bodily injury.
 - c. Computer systems upon which social or public infrastructure depends.
 - d. Devices which serve applications related to the above.

Contact your sales representative if you need to use the UPS in an application like the above. Special equipment, such as redundant devices or an emergency generator must be incorporated when operating, maintaining and controlling systems in which a UPS is used with loads affecting life-support or public infrastructure-dependent applications.
- Do not smoke or use an open flame near the UPS, as it could cause the UPS to explode or rupture, resulting in injury or fire.
- Do not place containers of liquid, such as a flower vase, on the UPS. If the container was to spill, the liquid could cause a short circuit, resulting in sparks or fire inside the UPS.
- Do not sit, step or lean on the UPS, as bodily injury could result if the UPS was to fall.

4. Maintenance and Inspection Precautions



CAUTION

- Maintenance and repair of the inside of the UPS should be performed only by technically qualified personnel. Electric shock, bodily injury and burns, fuming, or fire could otherwise result.
- Contact your nearest sales representative or authorized service center to have the UPS checked out or to replace defective parts. Opening the cover carelessly can result in an electric shock or burn.
- Do not allow sharp metallic objects or fingers to touch the battery connectors of the UPS. Doing so may result in an electric shock.
- Do not touch any parts inside the UPS, even when AC input is removed. Voltage produced from the batteries can still cause an electric shock.

5. Relocation and Transportation Precautions



CAUTION

- Be careful to avoid falling or dropping the UPS during relocation or transportation, as bodily injury could result.
- Be careful to avoid back strain when handling the UPS.
- To avoid bodily injury caused by dropping the UPS, do not tilt it more than 10 degrees to either side when moving it. Take preventative measures to avoid dropping the UPS if it must be tilted more than 10 degrees when moving it.

6. Battery Handling Precautions



CAUTION

- Battery servicing should be performed by technically qualified personnel. Keep unqualified personnel away from batteries.
- Replace batteries only with the same model "HHR-33AH72W4".
- The batteries in this product are the cylindrical nickel-metal hydride battery which are a reusable resource. Please cooperate by recycling when replacing or disposing of used batteries. Dispose of used batteries according to the instructions. Customers should not dispose of used batteries themselves. To dispose of used batteries, contact your nearest sales representative, an authorized industrial waste handling company.
- Do not use batteries after their service life has expired. Doing so may result in fuming or fire. Additionally, the battery backup function may fail to operate with such batteries, so that power will not be supplied to the load when a power outage occurs.
- Batteries pose hazards for electrical shock and dangerous short-circuit current. The following precautions should be observed when working with batteries:
 - a. Remove watches, rings and other metal objects.
 - b. Use insulated tools.
 - c. Wear rubber gloves and boots.
 - d. Do not lay tools or metal parts on top of batteries.
 - e. Disconnect the charging source prior to connecting or disconnecting battery terminals.
 - f. Determine whether the batteries have been inadvertently grounded, and if so, remove the source of grounding. Contact with any part of a grounded battery can result in electric shock.
- Do not attempt to open or disassemble batteries. The electrolyte is harmful to the skin and eyes. The battery contains nickel and strong alkaline solution, which is extremely toxic. If a battery leaks, take appropriate measures to prevent any battery fluid contacting your skin or clothing. Nickel and strong alkaline solution may cause blindness if it gets into the eye, may burn skin upon contact. It is electrically conductive and corrosive. Observe the following procedures if electrolyte spills:
 - a. Wear full eye protection and protective clothing.
 - b. If alkaline solution contacts the skin, wash it off immediately with water.
 - c. If alkaline solution contacts the eyes, flush thoroughly and immediately with water, and seek medical attention.
- The cylindrical nickel-metal hydride batteries can present a risk of fire due to generation of hydrogen gas. The following procedures should always be followed:
 - a. DO NOT SMOKE when near batteries.
 - b. DO NOT allow flames or sparks near batteries.
 - c. Before working with batteries, discharge static electricity from the body by first touching a grounded metal surface before touching the batteries.
- Do not dispose of batteries in fire, as they could explode.
- If a fire occurs near a battery, do not use water to extinguish it. Use only a powder-distinguishing agent (ABC). Using water can cause the fire to spread.
- Strictly observe the following precautions when handling the batteries. Failure to do so may cause battery leakage, overheating or explosion.
 - a. Do not solder to any part of the battery directly.
 - b. Do not charge the battery with reversed positive (+) and negative (-) terminal polarity.
 - c. Do not mix different battery types, brands or versions.
 - d. Do not attempt to peel off or break the outer covering of a battery.
 - e. Do not subject batteries to strong physical shock, or throw them away.
 - f. Electrical energy may remain in a battery even after its service life has expired. Do not allow sparks near used batteries, and protect them from short-circuiting.

2. Considerations for Proper Operation

2.1 Input Power Considerations

- (1) The model of UPS should match the AC line voltage (200, 220, 230 or 240 V AC $\pm 15\%$, and 50 or 60 Hz $\pm 5\%$ *). Specific voltages and corresponding models are as follows:

Voltage	200V	220V	230V	240V
1kVA	A11GN102A002	A11GN102A002-20	A11GN102A002-30	A11GN102A002-40
1.5kVA	A11GN152A002	A11GN152A002-20	A11GN152A002-30	A11GN152A002-40

* The factory default value for frequency range is $\pm 3\%$. If Input Frequency Range is $\pm 5\%$, you must select $\pm 5\%$. See “§12.2.3 Output Frequency Range Setting” for details. The frequency range setting is the same for the input and the output. If the frequency range is beyond the set range, the UPS will not switch into inverter mode due to abnormal input power.

- (2) The current capability of the AC supply must meet the requirements of the UPS (1.5 kVA).

2.2 Installation Considerations

- (1) Carefully consider the leakage current when a ground fault circuit interrupter is installed at the input side. The leakage current of the UPS is maximum 3mA.
- (2) Keep the UPS at least one meter (39.4in) away from CRT displays. Other devices which may be sensitive to magnetic flux should be kept away from the UPS, as it emits a slight amount of magnetic flux.
- (3) The UPS utilizes a fan for forced-air cooling. Provide at least 20 cm (7.9in) clearance at the front and back of the UPS to permit free airflow at the air intake and exhaust vents. At least one meter (39.4in) of space is recommended in front of the UPS to facilitate maintenance. See “§6.3 Installation Space” for details.
- (4) If the AC source has one side grounded, *the S terminal (phase) of the UPS must be the grounded phase.*
- (5) If possible, avoid grounding the output (load) side. If one side must be grounded, *the V terminal (phase) should always be the grounded phase* (to avoid short-circuiting power to ground).

2.3 Usage Considerations

- (1) Never short-circuit the output terminals, or connect a load which draws short-circuit current. Doing so causes protective functions or fuse opening to prevent output.
- (2) Unsuitable load devices
Do not connect laser printers, plain paper fax machines, copy machines or overhead projectors as load devices. Such devices typically include heating elements that draw high current. This may cause an overload that could prevent battery backup operation when an outage occurs, or damage the UPS.
- (3) Power supply environment
If the UPS is used in an environment subject to long and frequent power outages (more than once a week), the batteries may not receive sufficient charge, which could result in foreshortened battery life and premature battery failure.
- (4) If the UPS is not operated for 6 months or more, the battery may require charging before use. Operate the UPS with no load for at least 48 hours once every 6 months.
- (5) Insulation testing
Before testing indoor wiring insulation, shut down the UPS and disconnect the input and output cables. Conducting an insulation test with the UPS connected may damage electronic components such as the built-in arrester.
- (6) The UPS is designed to be installed horizontally. However, if it must be installed vertically, the left side should be the lower side (the indicators at the higher side), and Support brackets should be installed if needed. Refer to “§6.4 Support Bracket Installation” for details.
For rack mounting, an optional mounting bracket is required. Please contact your sales representative for details.

2.4 In Case of Trouble with the UPS

If one of the following trouble indications occurs, contact your nearest sales representative.

- (1) The ALARM indication lamp lights red (except when the UPS shuts down during a long power outage).
- (2) The INV. ON/STAND BY, INPUT and OUTPUT 0, 1 and 2 indicators don't light green during normal operation.
- (3) When any other symptom suspected to be a sign of trouble is observed.

3. Confirming Package Contents

When opening the package, please confirm the proper contents and contact your nearest sales representative if you find any discrepancy.

(1) UPS Unit	1
(2) Accessories	
Instruction Manual(this booklet)	1
Sheet for additional information	
Setting Up the UPS	1
Bypass Fuse 15A	2
Support Brackets	1 set
Support Bracket Screws	4
Input Cable*	1
Communication Cable	1
Plastic Hole Plugs	6

*Do not use this cable with devices other than this one.

4. Overview

This uninterruptible power supply is designed to provide clean, stable and uninterrupted AC power to important devices.

The UPS consists of rectifier, charger, inverter, battery and commercial power transfer (bypass) circuits. In the event of failure of the AC source (utility power), inverter operation is sustained by converted DC power supplied from the batteries. When the utility power recovers, inverter operation continues while the battery is recharged. The UPS is therefore able to supply completely uninterruptible AC power to connected loads without so much as a moment of power loss.

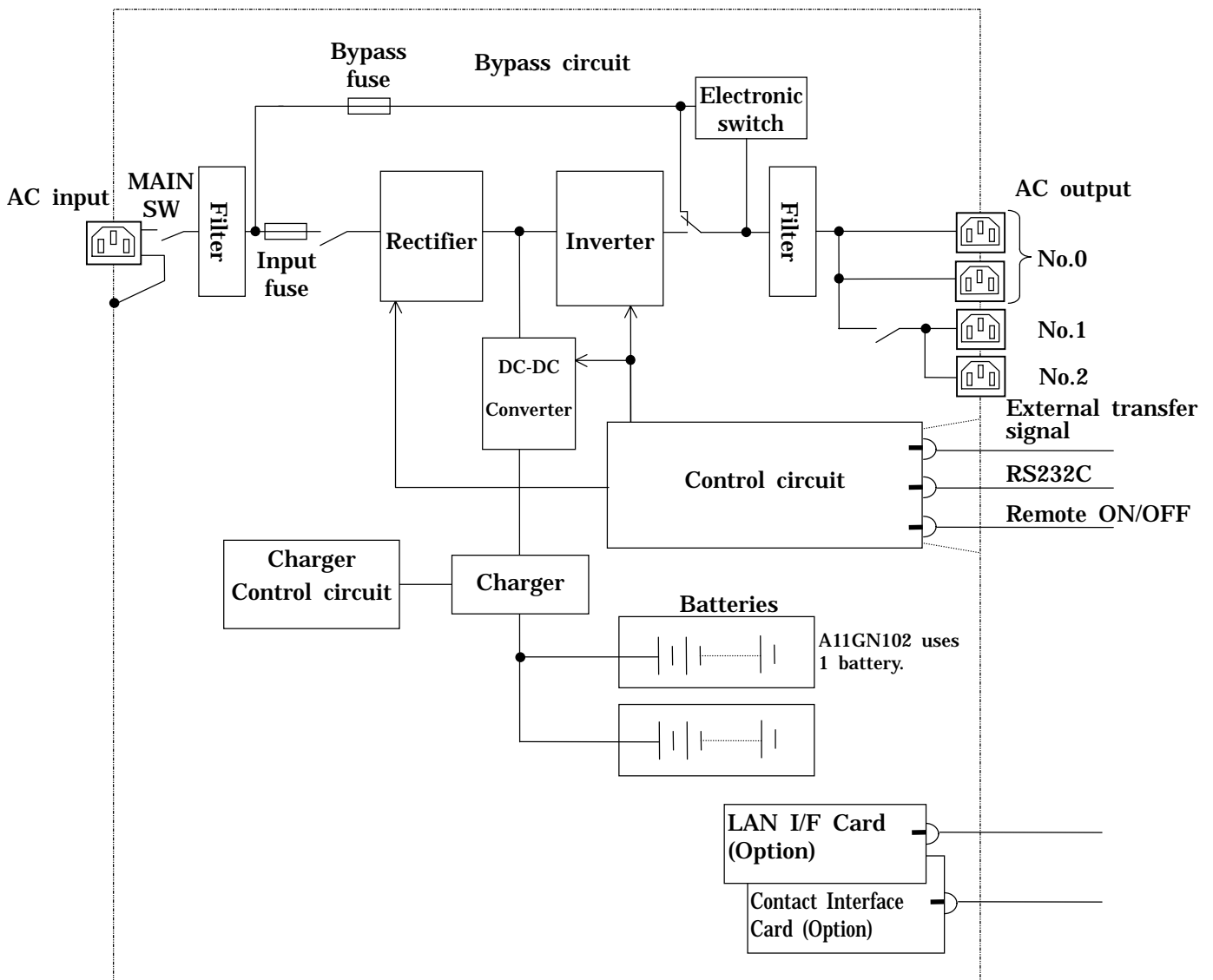

UPS Block Diagram

Inlet:	IEC60320 C14	
Outlet(Un-switched outputs):	IEC60320 C13	2PCS.
Outlet(System-controlled outputs):	IEC60320 C13	2PCS.

5. External Dimensions and Part Names

5.1 Overall Unit

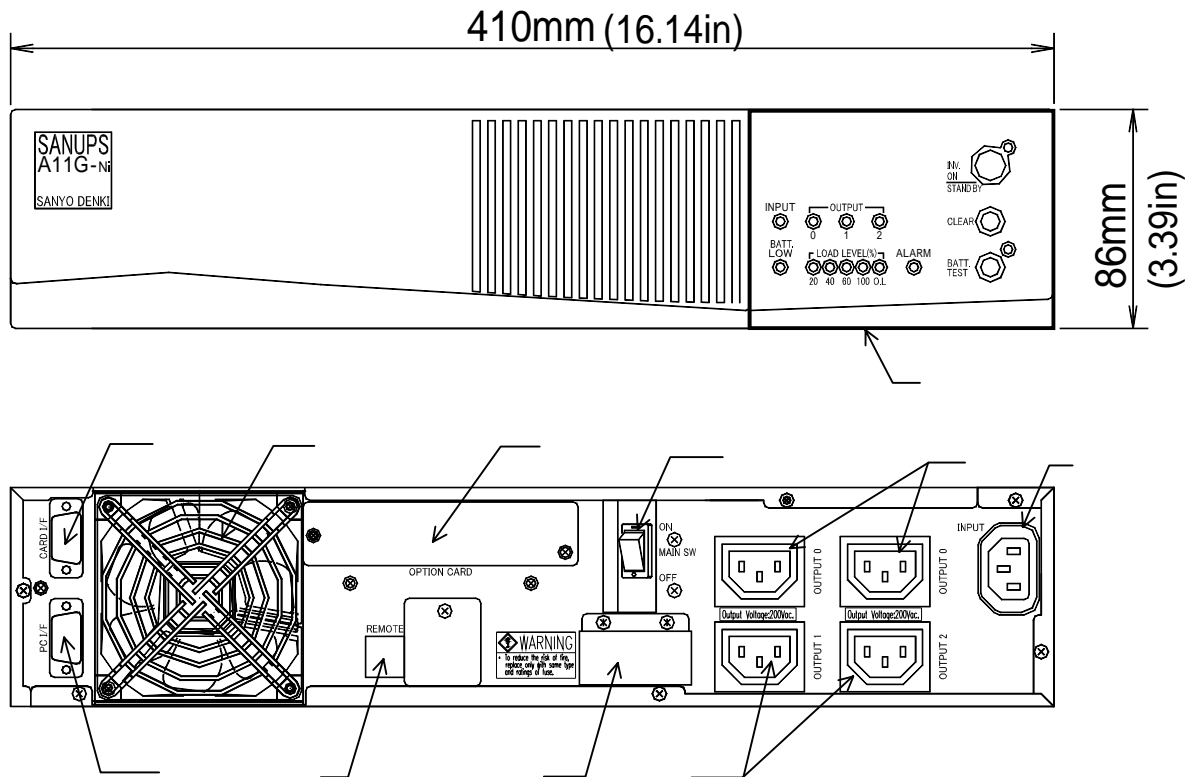

Depth: 540 mm (21.26in)

Weight: 19kg(41.9lbs):A11GN102 , 24kg(52.9lbs):A11GN152

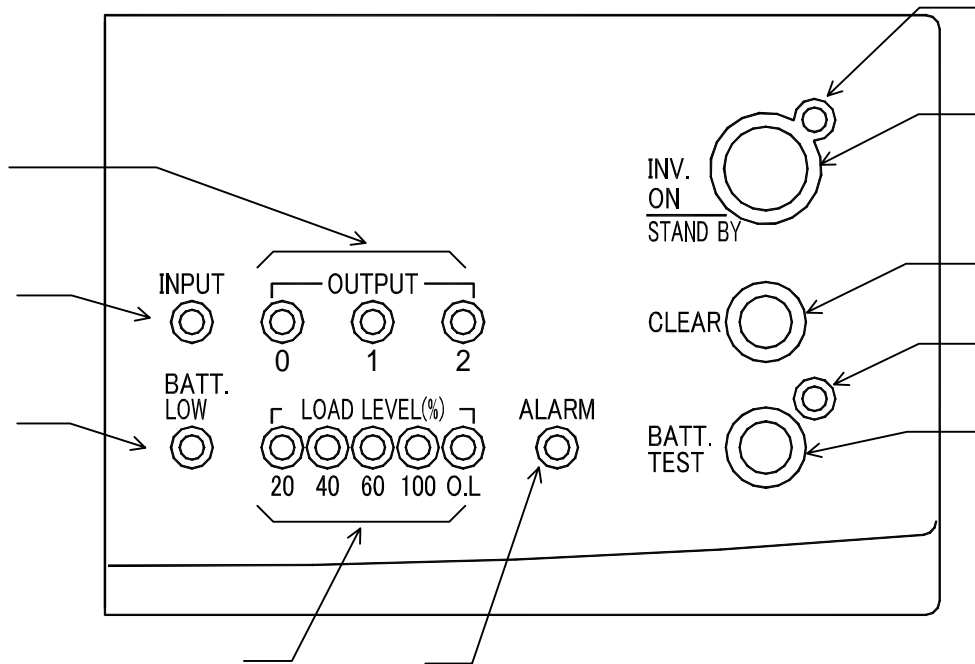

No	Name	Marking	Function
	Control Panel, Indicators	-	Operating controls and indicators
	Card Interface Connector	CARD I/F	For ext. equipment and card option
	PC Interface Connector	PC I/F	For a PC or workstation
	Cooling Fan Vent	-	Cooling
	Optional Card Slot	OPTION CARD	Optional card installation compartment
	Main Switch	MAIN SW	Utility power input ON/OFF
	Remote ON/OFF Connector	REMOTE	Interface for remote ON/OFF switch
	Bypass Fuse	FUSE	Bypass circuit protection
	Outlet	OUTPUT 0	Un-switched outputs
	Outlet	OUTPUT 1,2	System-controlled outputs
	Inlet	INPUT	Connect the input cable

5.2 Control Panel, Indicators



No	Name	Marking	Function
	INV. ON/STAND BY Switch	INV. ON/STAND BY	Selects either ON or STAND BY inverter operation
	INV. ON/STAND BY Indicator	-	Output power is supplied by: Inverter (LED on) Bypass (LED blinking)
	Clear Switch	CLEAR	Stops the beeper, clears battery test results
	Battery Test Switch	BATT. TEST	This UPS has auto battery test function, so the function of this switch is not available.
	Battery Test Indicator	-	Unavailable indicator.
	Alarm Indicator	ALARM	Lights if the UPS fails, and when the batteries are discharged below minimum operating voltage.
	Input Indicator	INPUT	Lights when input utility power is normal, and blinks when input power is abnormal.
	Output Indicators	OUTPUT	Output power is supplied by: Inverter (LED on) Bypass (LED blinking)
	Load Level Indicator	LOAD LEVEL	Indicates the load level (20, 40, 60, 100% or O.L [Overload])
	Battery-Low Indicator	BATT.LOW	Lights when the followings occur: the battery voltage is low, or the charger is error. Blinks when the battery has reached its service life.

In this manual, switches are depicted as (e.g.: INV. ON/STAND BY).

The status of LEDs on the control panel are indicated as  for lit, and  for blinking.

6. Carrying and Installation



CAUTION

A11GN102 weighs about 19kg(41.9lbs), and A11GN152 weighs about 24kg (52.9lbs).

- Install the UPS on a stable surface that can bear the weight of the UPS.
- This surface should be flat, so the UPS cannot fall and cause bodily injury.
- The possibility of vibration and shock should be minimized at the installation location.
- Be careful to avoid straining your lower back when carrying and installing.
- The UPS may fall or be dropped during relocation or installation. Always hold the UPS securely by the upper corners. Bodily injury could result if the UPS falls to the floor.

6.1 Environment

Do not install the UPS in the following locations:

- Where the ambient temperature exceeds 40°C (104° F).
For optimum battery life, install the UPS where the ambient temperature remains between 20 to 25°C (68 to 77° F).
- Where high humidity may occur.
- Where corrosive gas or salt spray may be present.
- Where it may be subject to vibration and shock.
- Where dust may accumulate.

6.2 Carrying

Carry the UPS within its packing carton, removing it only when near the installation location.



CAUTION

- To avoid bodily injury from dropping the UPS, do not tilt it more than 10 degrees to either side when moving it. Take preventative measures to avoid dropping the UPS if it must be tilted more than 10 degrees when moving it.

6.3 Installation Space

The UPS is designed to be installed either horizontally or vertically on the floor. When installed vertically, the left side should be the lower side (the indicators at the higher side), and the Support brackets should be installed. Refer to “§6.4 Support Bracket Installation” for the mounting procedure.

Provide the following space around the UPS.

- At least 20 cm (7.9in) at the front as air intake space for the cooling fan.
- At least 20 cm (7.9in) at the back as air exhaust space for the cooling fan.
- At least 1 meter (39.4in) at the front for maintenance when needed
- At least 1 meter (39.4in) from CRT displays to allow for slight leakage of magnetic flux. Allow some space from devices which might be affected by magnetic flux.

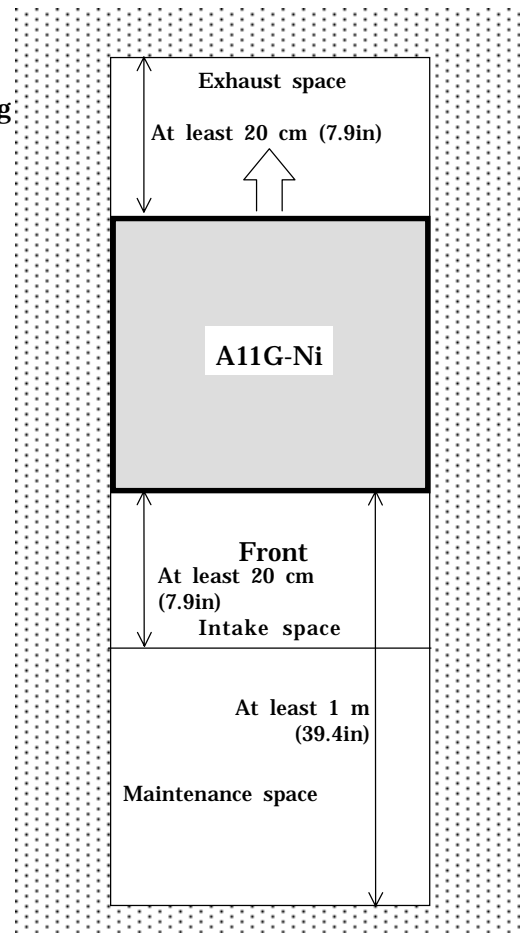

6.4 Support Bracket Installation

Install the Support brackets as follows.

Place the UPS on a desk surface.

Affix the supplied Support brackets to the left side of the UPS with the supplied screws.

Turn the UPS so that it stands on the Support brackets.

Be sure to install the UPS so that when turned on its side, the left side is down and the control panel is nearest the top.

 CAUTION	<ul style="list-style-type: none">• If the brackets are not securely attached, bodily injury could occur if the UPS was to fall over from shock or vibration.• Be careful not to pinch your fingers when mounting
--	--

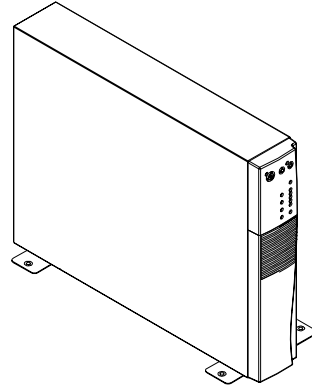
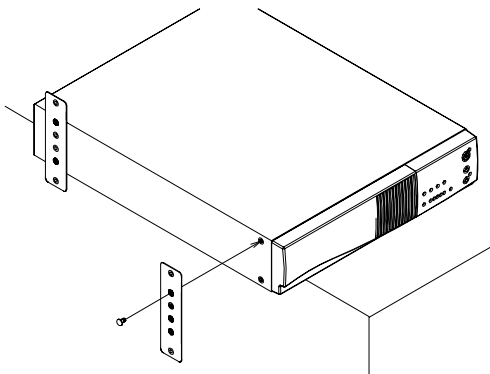

If set the UPS against a wall, use the holes at the appropriate end of the brackets so that the brackets do not interfere with positioning the UPS.

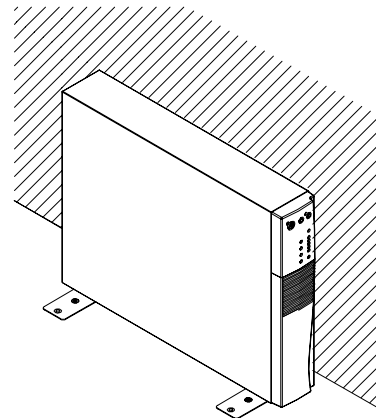
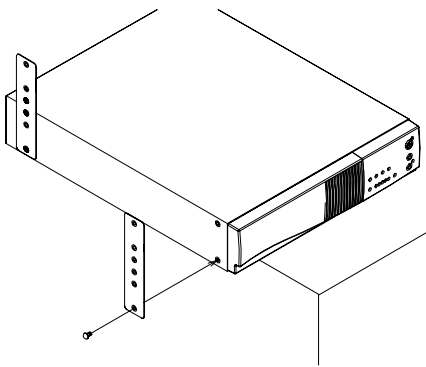

6.5 Plastic Hole Plug Installation

If the Support brackets or a mounting rack is not used, insert the supplied plastic hole plugs into any unused mounting holes.

Left side: 4 holes

Right side: 2 holes

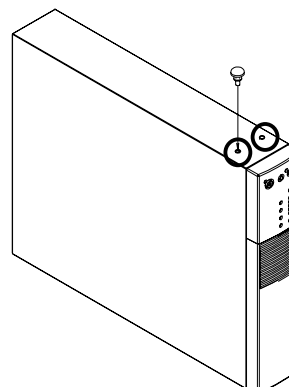
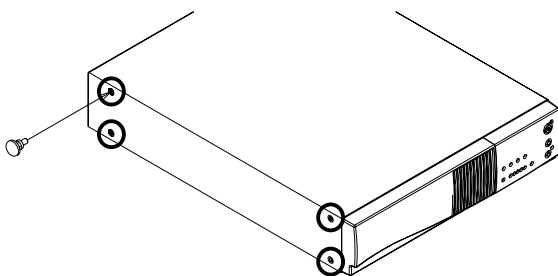

7. Wiring



- Obtain the assistance of technically qualified personnel for wiring. Incorrect wiring can result in electric shock, injury or fire.
- Make sure the input plug, outlet connections and external control plug are firmly connected. A loose plug can cause smoke or fire.
- Make sure the ground pin of the input plug connects to earth ground. Otherwise, there is danger of electric shock. 

7.1 UPS Wiring

Verify that the **MAIN SW** is turned OFF.

Connect the UPS input plug to a commercial mains outlet.

Connect the Input plug of the INPUT CABLE to a commercial mains outlet.

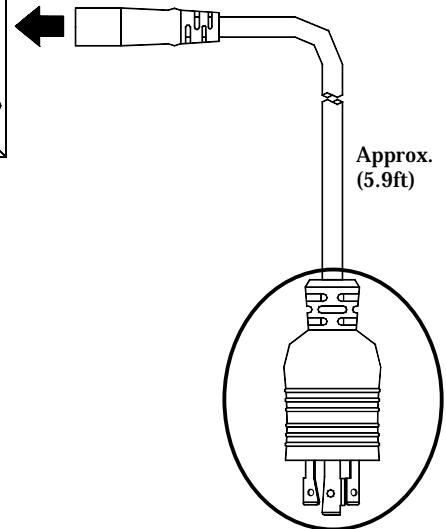
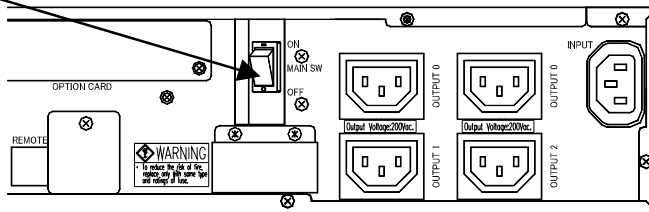

Input Plug (L6-20P)
(viewed from pin side)



CAUTION
If the AC source has one side grounded, the *N terminal (phase)* of the UPS should be the grounded phase.

To commercial mains AC power
2-electrode + ground outlet

7.2 Load Device Connections

Plug the load devices into the outlets on the UPS.

Select the appropriate outlet type to suit the requirements of the load device.

- | | |
|-----------------------|--|
| OUTPUT 0 | Un-switched |
| OUTPUT 1 and 2 | Timer-controlled outputs (see “§12.2.1 OUTPUT 1 and 2 Timer Control Settings”). |

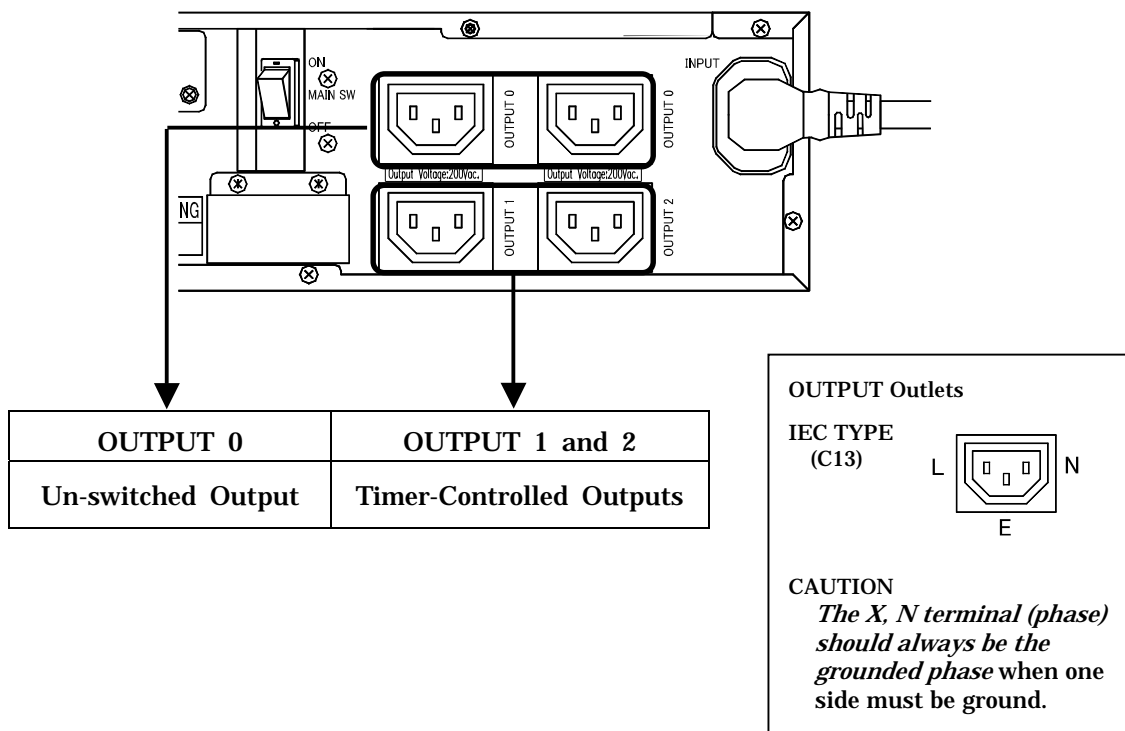

Load Connection Precautions

- The OUTPUT 0 outlets provide uninterruptible power even when the inverter stops. Use these outlets for loads that require uninterrupted power, and for those that do not require power to be switched on and off.
- Use the OUTPUT 1 and OUTPUT 2 outlets for loads that require power to be switched on and off.

7.3 External Control Signals

(1) External Interface Connector (CARD I/F)

This connector is specially designed for use with Sanyo card options (network interface card and contact-point card). If you wish to use this connector for other devices, please contact your nearest sales representative.

(2) PC/Workstation Interface Connector (PC I/F)

This connector can be used to control power by external communications from a computer (such as a PC or workstation) using the optional SANGUARD power control software. Use the supplied communications cable for connection.

- Interface Setting: W/S Mode

Signals are supported for the UPS monitoring functions of network operating systems (such as Netware and Windows NT).

By connecting a computer with the supplied communications cable, automatic shutdown can be controlled by the UPS services in Windows NT.

- Interface Setting: Stand-Alone Mode

Precautions for using UPS monitoring functions

- In the UPS Configuration window of the operating system, the Remote UPS Shutdown setting should be set to Positive. Refer to the documentation for your network operating system for details.
- If the operating system does not support UPS monitoring functions (such as Windows 95 and 98), do not use the supplied communications cable for connection, as back-up will not occur in the event of a power outage.

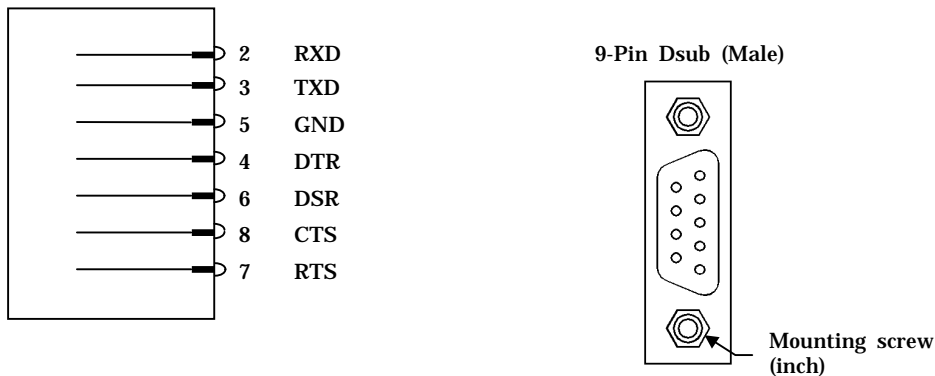

Note1. Interface is selected from the front panel. See "§12.2.5 PC Interface Selection" for details.

(3) Remote ON/OFF Connector

This connector can be used for optional remote ON/OFF switching control.

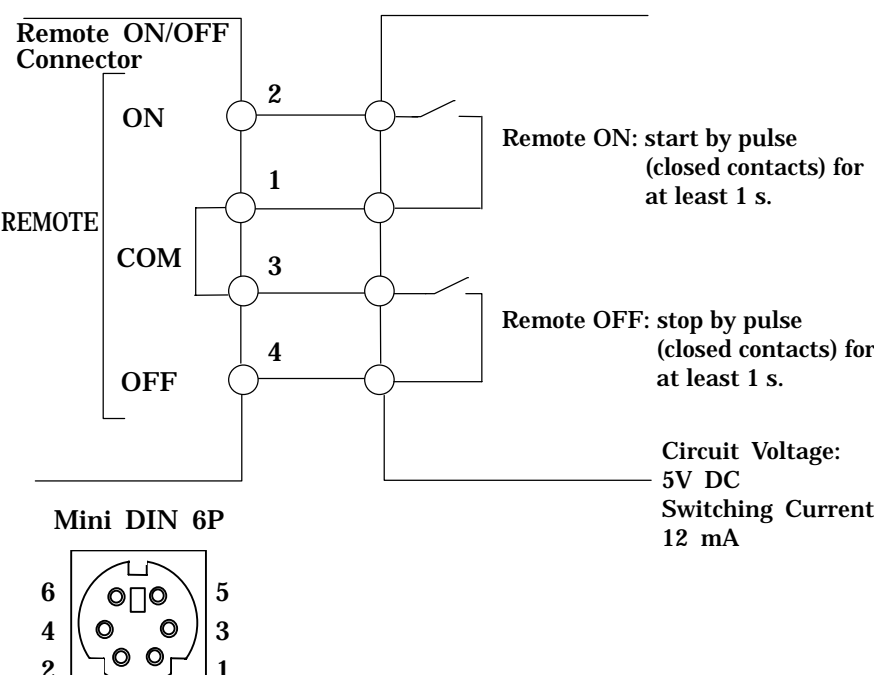
Signal Name	Description
Signal Input	<p>The UPS can be remotely switched on and off by closed-circuit contact switching signals. The contacts should be those of a device such as a push-button switch.</p>  <p style="text-align: right;">Circuit Voltage: 5V DC Switching Current: 12 mA</p>

Operation is as follows according to the interface setting:

- Stand-Alone Mode: Remote ON/OFF
- Workstation(W/S) Mode: Remote ON/One-Touch Shutdown

Note 1. The Stand-Alone and Workstation(W/S) Modes are selected from the front panel.

See “§12.2 User Settings” for details.

8 . Preparations Before Operation

Check the following items before starting operation.

Visually inspect the UPS to verify that there is no visible damage.

Connect the UPS to a utility power source that meets the input specifications.

Verify that the **MAIN SW** is turned OFF.

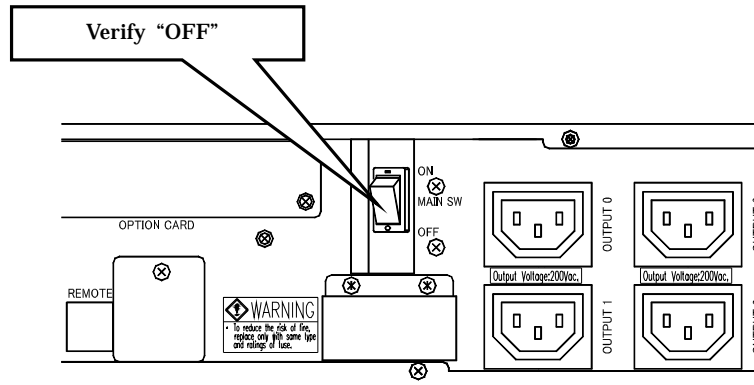

9. Operation

9.1 Starting Operation (Normal Start)

Turn the **MAIN SW** on the rear panel ON.

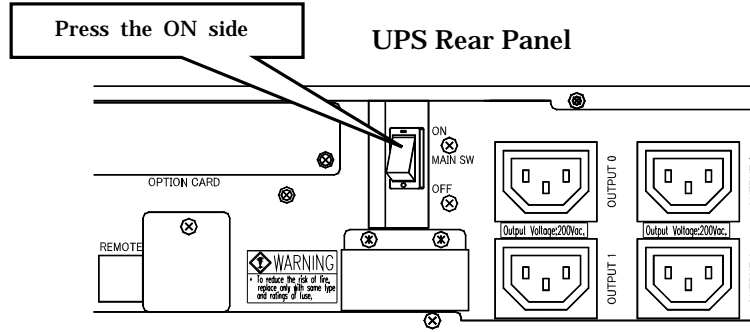

Device Status	LED
Cooling fan rotation, Rectifier Charger starting, Battery charge starting	INPUT (green) On
OUTPUT 0 bypass operation starting	INV. ON/STAND BY (Green) Blinking OUTPUT 0 (Green) Blinking

UPS Front Panel

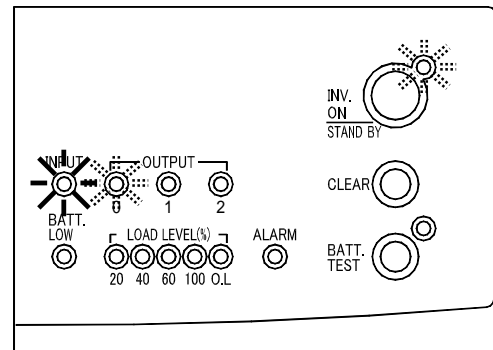

Press the **INV. ON/STAND BY** switch for at least 1second.

Beeper Sound - beep

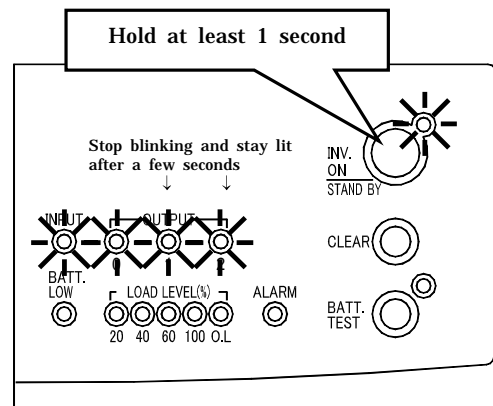

Device Status	LED
OUTPUT 0 Bypass operation continue	INPUT (Green) On
OUTPUT 1,2 Bypass operation starting	INV. ON/STAND BY (Green) Blinking OUTPUT 0 (Green) Blinking OUTPUT 1, 2 (Green) Blinking
After a second or two, the inverter starting. Power supply route is switched from bypass to inverter	INPUT (Green) On INV. ON/STAND BY (Green) On OUTPUT 0, 1, 2 (Green) On



Note

OUTPUT 1 and 2 operation can be programmed by timer settings. If start/stop times are set for OUTPUT 1 and 2, output power is enabled after the set time has passed.

In this manual, switches are depicted as (e.g.: **INV. ON/STAND BY**).

The status of LEDs on the control panel are indicated as  for lit, and  for blinking.

9.2 Starting Operation (Battery Start)

If the status of utility power input is abnormal (such as an outage or low voltage), the UPS provides AC power output from the batteries through the inverter.

Verify that the **MAIN SW** on the rear panel is turned OFF.

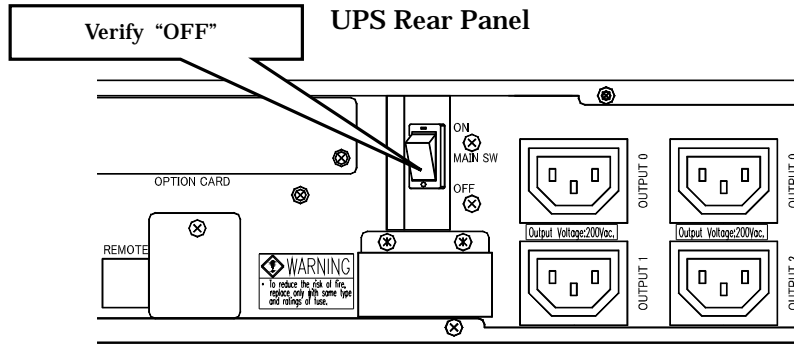

UPS Front Panel

LEDs	
All off	

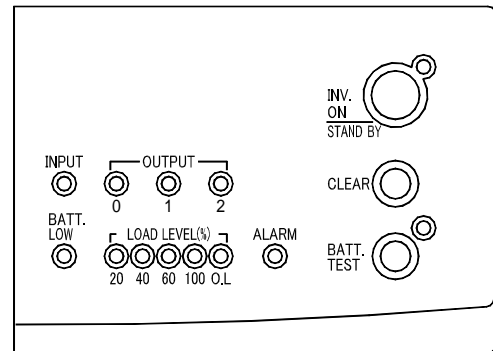

Press and hold the **INV. ON/STAND BY** switch for at least 6 seconds.

Beeper sound "Beep"
 ↓
 Beep-beep...beep-beep...

LEDs	
INPUT (Green)	Blinking
INV. ON/STAND BY (Green)	On
OUTPUT 0, 1, 2 (Green)	On

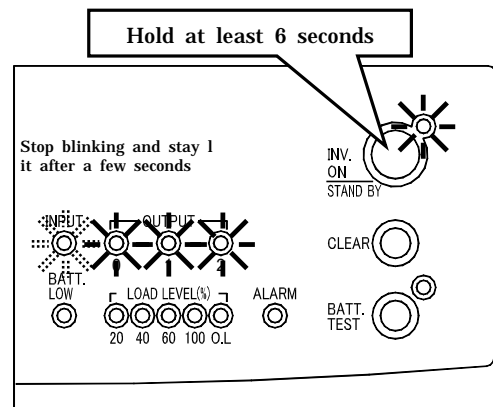

Note

OUTPUT 1 and 2 operation can be programmed by timer settings.

If start/stop times are set for OUTPUT 1 and 2, output power is enabled after the set time has passed.

Turn the **MAIN SW** on the rear panel ON.

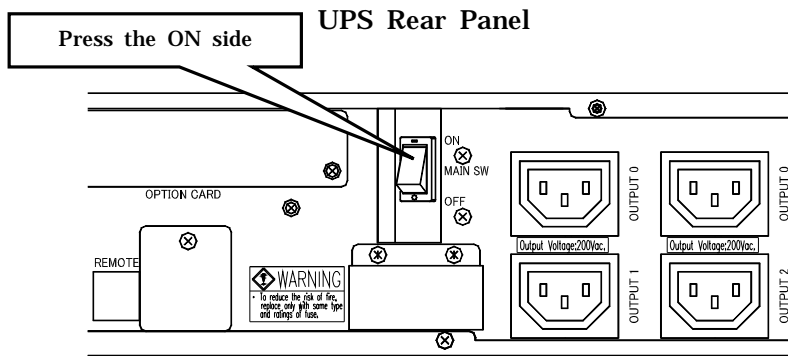

Caution

When the **MAIN SW** is not turned ON, even when utility power (AC input) returns to normal, the UPS cannot switch from the internal supply back to the utility power, so operation is the same as during an extended outage, and the batteries will be discharged. Be aware that, when restarting from this condition, the UPS backup function will not be fully operational until the batteries have had time to recharge.

9.3 Power Outage Simulation Test

The power outage simulation test is performed to verify that the UPS is functioning properly. This test is not needed when starting from the batteries (see §9.2).

The following indicates normal conditions.

Note
Perform this test before turning on connected loads.

Turn off the distribution panel breaker supplying AC input.

Beeper sound: Beep-beep...beep-beep...

Device Status	LED
Inverter operating from battery, Output supply continues	INPUT (Green) Blinking INV. ON/STAND BY (Green) On OUTPUT 0, 1, 2 (Green) On

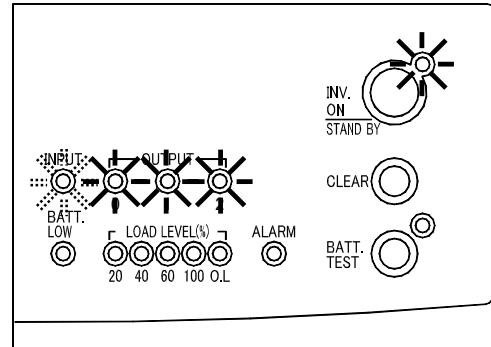

Turn the distribution panel breaker back on.

Beeper sound: stops

Device Status	LED
Rectifier, Charger starts Battery charging starts	INPUT (Green) On INV. ON/STAND BY (Green) On OUTPUT 0, 1, 2 (Green) On

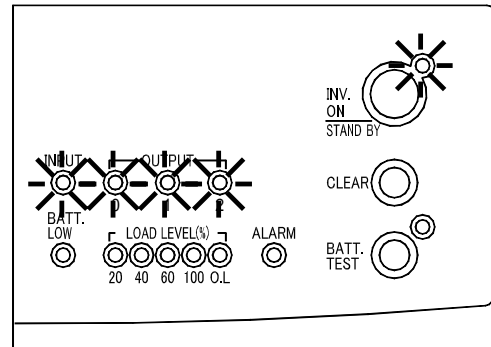

Note

If the distribution panel is not readily accessible, unplug and replace the AC supply plug of the UPS, or turn the **MAIN SW** switch ON and OFF.

When unplug and replace the AC supply plug of the UPS, low voltage (less than 30V) is presented at the input plug with inverter operating. Avoid touching the metal-parts or causing a short circuit.

9.4 Operation Shutdown (Daily)

Press and hold **INV. ON/STAND BY** for at least 1 second.

Beeper sound: beep

Device Status	LED
Inverter stopped	INPUT (Green) On
OUTPUT 0 bypass operation	INV. ON/STAND BY (Green) Blinking OUTPUT 0 (Green) Blinking
OUTPUT 1,2: stopped	OUTPUT 1,2 (Green) Off
Rectifier, charger operation continue	

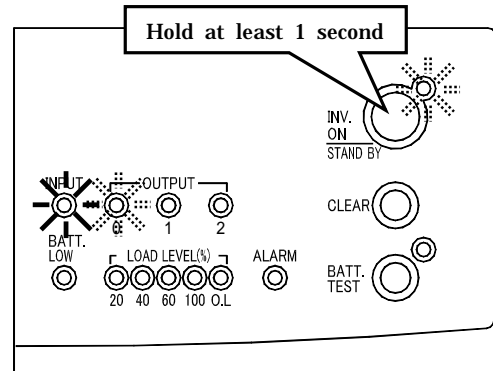

Note

For daily shutdowns, the **MAIN SW** should be kept ON (not used).

If OFF Delay times are set for OUTPUT 1 and 2, the outputs turn off after the set times. OUTPUT 0 can be turned off only by the **MAIN SW**.

In Stand-Alone Mode:

- When **INV. ON/STAND BY** is switched to STANDBY, the AC supply route is switched from the inverter to bypass. In this case, if OFF Delays have been set, OUTPUT 1 and 2 shut off after the Off Delay time has elapsed.
- To resume inverter power supply operation after the OFF Delay time, use the optional LAN card or “SanGuard IV Lite” power supply control software to make the setting to W/S mode.

9.5 Operation Shutdown (If UPS is not to be used for a week or more)

Hold **INV. ON/STAND BY** for at least 1 second.

Turn **MAIN SW** OFF.

Device Status	LED
Inverter stopped	INPUT (Green) On
OUTPUT 0 bypass operation	INV. ON/STAND BY (Green) Blinking OUTPUT 0 (Green) Blinking
OUTPUT 1,2 stopped	OUTPUT 1,2 (Green) Off
Rectifier, charger operation continue	
Rectifier, charger stopped	All turn off
Cooling fan rotation stopped	

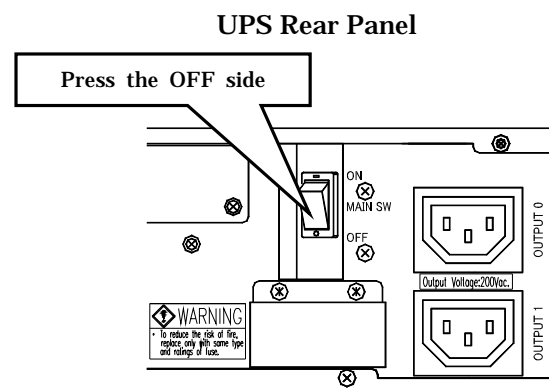

Unplug the input plug.

Note

If the input supply is removed while the UPS is on, the batteries are discharged the same as during an extended outage. Be aware that when the input supply is restored, the full capacity of the back-up function will not be available until the batteries have had time to recharge.

10. Operating and Protective Functions

10.1 Basic Operation

(1) Under normal conditions

Basically, the UPS converts AC power from the commercial source (AC input) into DC power through the rectifier, and reconverts this DC power back into AC power through the inverter. The reconverted AC power is synchronized with the commercial source to ensure a stable power supply to the loads. The batteries are kept continually charged and ready in case a problem (outage or voltage drop) occurs in the commercial power supply.

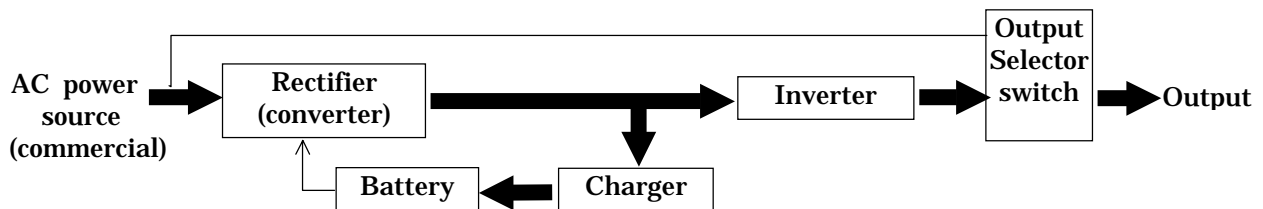

Power supply route in normal operation

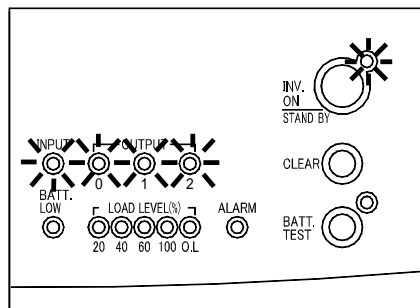

Display status

(2) Upon failure of commercial power

When a fault or an outage occurs in the commercial power source, the rectifier and charger cease operating while inverter operation continues, now using the batteries as a DC source, to ensure stable power supply to the loads without even a momentary power dropout. At this time, the battery operation beeper sounds and the green INPUT indicator lamp blinks. Pressing **CLEAR** silences the beeper.

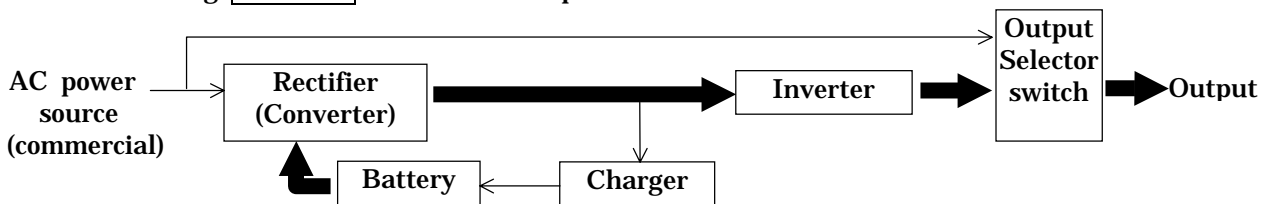

Power supply route upon failure of commercial power

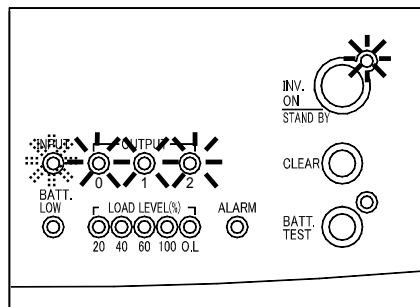

Display status upon failure of commercial power

(3) When battery voltage becomes low

If the commercial power abnormality or outage persists, the BATT.LOW (low battery voltage) indicator on the upper display lights.

(4) Upon recovery of commercial power

When normal commercial power recovers, rectifier and charger operations resume automatically, returning to the normal operating state described in (1).

(5) Extended power outage

If a power outage persists and the battery voltage reaches the final discharge level, a protective circuit shuts off the inverter to prevent overdischarging the batteries. When normal commercial power recovers after the inverter has been stopped automatically, operation is automatically resumed, returning to the normal operating state described in (1).

10.2 Protective Functions

(1) Overload Protection

If the UPS outputs are overloaded by exceeding the current capacity of the inverter, such as when a computer system boots up, the output selector switch automatically switches the source of AC power from the inverter to the bypass source without interruption. After a certain period of time has elapsed, the source of AC power is switched back to the inverter without interruption (auto return).

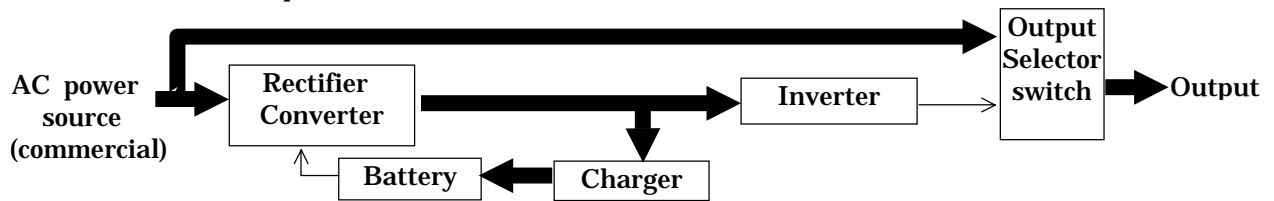

Power supply route in overload state

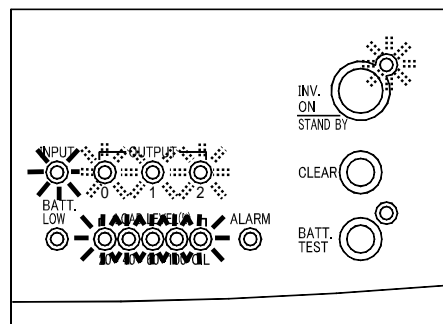

Display status in overload state

(2) Inverter Fault Protection

If a fault occurs in the inverter, the output selector switch automatically switches the source of AC power from the inverter to the bypass source without interruption. In this case, the red ALARM indicator lights and the beeper starts sounding. The power supply route is the same as shown above for the overload state.

Pressing **CLEAR** silences the beeper.

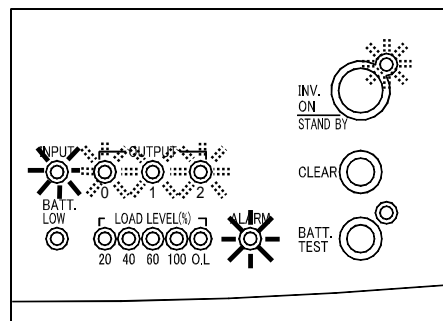

Display status in case of inverter fault

Note 1. When a fault occurs in the UPS

If a power outage occurs while bypass power is being supplied due to malfunction of the inverter, output is shut off. If such troubles occur, contact your local representative as soon as possible.

10.3 Protective Function Chart

The protective functions listed in this table protect the UPS and connected devices.

: Indicates a lamp lights, beeper sounds and an external signal is sent

Item	Control (front panel) indicators					Warning	External signal output: contact Interface Card output (option)						Protective function (UPS operation)	Note
	INPUT (green)	OUTPUT (green)	ALARM (red)	O.L (red)	BATT.LOW (red)	Beeper (Note1)	AC input Abnormal	Battery Voltage low	AC output	Bypass Output	UPS abnormal			
00	Preparation	-	-	-	-	-	-	-	-	-	-	-	Rectifier, charger operation	Receiving AC power
01	Normal		-	-	-	-	-	-	-	-	-	-	Inverter operation	Receiving AC power, start
02	Serious error	(blink)	-	-	-	(1)	-	-					Inverter is turned off Bypass power supply	
03	Overload (Operating value)	(blink)	-	-	-	(4)	-	-			-	-	Bypass power supply	Auto return
04	Forced bypass	(blink)	-	-	-	-	-	-			-	-	Bypass power supply	Manually switch to bypass AC power source
05	Input overvoltage	(blink)	-	-	-	(2)		-			-	-	Rectifier and charger turned off Inverter power supply is continued	Battery operation
06	Input overvoltage (prolonged)	(blink)	-	-		(3)					-	-	Rectifier and charger turned off Inverter power supply is continued	Battery operation Inverter turns off when battery discharging stopped.
07	Power outage	(blink)	-	-	-	(2)		-			-	-	Rectifier and charger turned off Inverter power supply is continued	Battery operation
08	Power outage (prolonged)	(blink)	-	-		(3)					-	-	Rectifier and charger turned off Inverter power supply is continued	Battery operation Inverter turns off when battery discharging stopped.
09	Input abnormal (Frequency)	(blink)	-	-	-	(2)		-			-	-	Rectifier and charger turned off Inverter power supply is continued	Battery operation
10	Input abnormal (prolonged)	(blink)	-	-		(3)					-	-	Rectifier and charger turned off Inverter power supply is continued	Battery operation Inverter turns off when battery discharging stopped.
11	Battery service life expiration		-	-	(blink)	(5)	-				-	-	Inverter power supply is continued	
12	Charger abnormal	(blink)	-			(1)	-	-					Inverter is turned off Bypass power supply	

Note 1. Pressing **CLEAR** on UPS front panel silences the beeper. If such trouble occurs, contact your local sales representative.

- Beeper alarm sounds:
- (1) Beep————— (continuous)
 - (2) Beep beep·····beep beep·····
 - (3) Beep beep beep beep·····
 - (4) Beep beep beep beep·····Beep beep beep beep·····
 - (5) 5 beeps... 5beeps... 5beeps...

11. Maintenance and Inspection

 CAUTION	<ul style="list-style-type: none"> • Internal maintenance and inspection should be performed only by technically qualified personnel. Electric shock, injury, burning, smoke or fire could otherwise result. • Perform inspection only after the input power has been turned off and the UPS has completely stopped. Electric shock hazards may be present. • As electrical parts remain charged as long as the batteries are connected, never touch them. Electric shock hazards may be present.
---	--

11.1 Daily Inspection

- (1) Observe the control panel LEDs to confirm that no abnormality is indicated.
If you find the red BATT.LOW blinks, the battery has reached its service life. Contact your supplier to replace the battery.
- (2) Damage can occur if dust accumulates on internal components, so remove any dust or grime from the intake and exhaust vents.

11.2 Battery Inspection

 CAUTION	<ul style="list-style-type: none"> • Battery replacement should be performed only by technically qualified personnel. Electric shock, injury, burning, smoke or fire could otherwise result. • Batteries should be replaced periodically. Batteries that have passed their service life may cause a fire.
--	---

- (1) **Battery Backup Confirmation**
Battery backup capacity is tested automatically. See “§12.1 Battery Test”. And according to the test result indication, contact your supplier when battery replacement is needed.
- (2) **Battery Replacement Period Prediction**
Battery life is affected by operating conditions such as ambient temperature and number of discharges. Ambient temperature has a particularly strong influence as indicated in the following table (refer to the table to predict when batteries will need to be replaced according to ambient temperature). Using batteries after their life expectancy can cause leakage, and in the worst case damage may result, so we recommend changing batteries early as a preventative and protective step.

Ambient Operating Temperature	Life Expectancy	Battery Replacement Period
25°C (77° F)	10 years	-
30°C (86° F)	8 years	7.5 years
35°C (95° F)	6 years	5.5 years
40°C (104° F)	4 years	3.5 years

12. Special Functions

12.1 Battery Test

This UPS performs the battery test automatically. And test result is indicated by the LED and the buzzer. When the battery has reached its service life, the battery test result is shown as follows. If you find this indication, contact your supplier to replace the battery.

Battery test result

Indication	Alarm Sounds	Judgment
BATT.LOW Red LED blinking	5 beeps... 5 beeps... 5 beeps... continuously	Battery replacement is recommended.

How to stop the buzzer sound.

Press **CLEAR** for at least one second to stop the buzzer sound.

The buzzer stops, the red BATT.LOW blinks continuously.

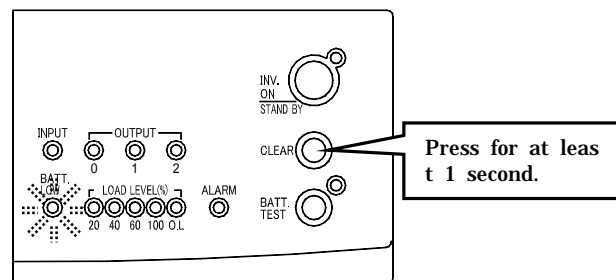

Note

This test provides only rough information. Even if the test result is not indicated, please contact your service representative or SANYO DENKI's office when the battery expiration date arrives.

12.2 User Settings

The user can make the following settings:

- (1) OUTPUT 1 and OUTPUT 2 Timer Control Settings
(ON Delay, OFF Delay, Output after power outage 5 seconds to 10 minutes)
- (2) Power Outage Beeper Setting (Beep/Silent)
- (3) Output Frequency Range Setting (1, 3 or 5%)
- (4) OUTPUT 0 Operation After OUTPUT 1 and 2 Shutdown During Power Outage
(Continue/Shut down)
- (5) PC Interface Selection (Stand-Alone or W/S Mode)
- (6) Communications Baud Rate Selection (9600, 4800 or 2400 bps)
- (7) Ring Signal Start Setting (Enable/Disable)
- (8) Battery Starting Frequency (50/60 Hz)

Note

To change user settings, the UPS must be stopped and restarted after changing settings. Otherwise the new settings will not take effect. See “9.5 Operation Shutdown” and “9.1 Starting Operation”. Stop the load devices, when the UPS is shut off.

How to configure user settings

All settings are performed using the following procedure.

During inverter or standby operation, press **CLEAR** for at least 3 seconds.

UPS status
「Beep beep...」 beeper sound
Setting mode
INPUT (green) blinking
BATT.LOW (red) blinking

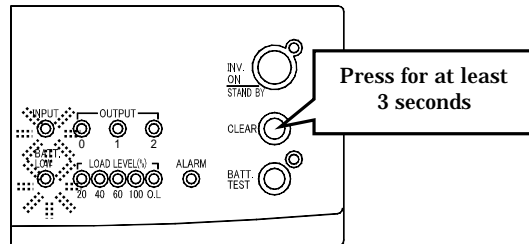

The blinking pattern of the upper four LEDs now indicates the item to be set, selected by pressing **CLEAR** briefly (less than 3 seconds). See the following pages for the blinking pattern of each setting item. Pressing **CLEAR** repeatedly changes which LEDs blink, so press it as necessary to select the item to set.

UPS status
The beeper sounds once at each press.
The pattern of blinking upper LEDs changes.

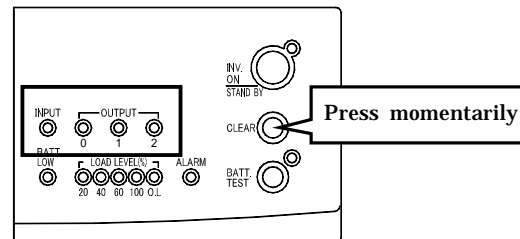

The blinking pattern of the lower three LEDs indicates the current setting value, selected by pressing **BATT.TEST**. See the following pages for the blinking pattern of each setting value. Pressing **BATT.TEST** repeatedly changes which LEDs blink, so press it as necessary to select the desired setting value.

UPS status
The beeper sounds once at each press.
The pattern of blinking lower LEDs changes.

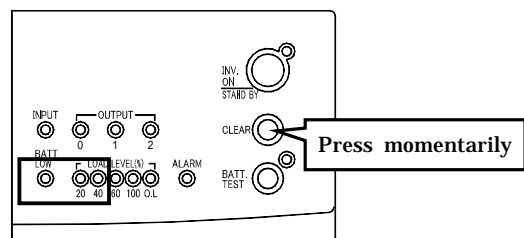

Press **CLEAR** for at least 3 seconds when finished making settings.
Two beeps sound, the setting status is memorized, and normal operation resumes.

Note

To reset all settings to their default values (initial states), press and hold **CLEAR** for more than 3 seconds after the beeper sounds in step 4 above.

12.2.1 OUTPUT 1 and 2 Timer Control Settings

Sets the shut-down indication and timer, etc., according to user requirements.

- Blinking
- Off
- * - Default setting

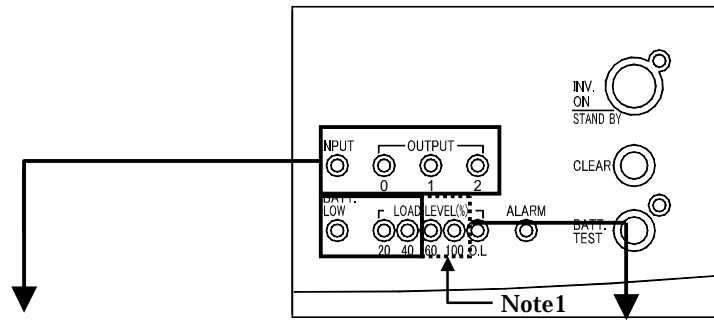

Setting item	Item LED indication	Setting value	Setting value LED indication
OUTPUT 1 OUTPUT 2 ON Delay		0*	
		5 s	
		30 s	
		1 min	
		5 min	
		10 min	
		Note1	
OUTPUT 1 OUTPUT 2 OFF Delay		0*	
		10 s	
		30 s	
		1 min	
		3 min	
		5 min	
		Note1	
OUTPUT 1 OUTPUT 2 Output time after outage		Until UPS shutdown*	
		0 s	
		30 s	
		1 min	
		3 min	
		5 min	

Restart of the UPS is not required to make setting change effective.

During Stand-Alone Mode

- The operating mode changes from inverter to bypass when **INV. ON/STAND BY** is set to OFF. In this case, if an OFF Delay is set, OUTPUT 1 and 2 shut off after the set Off Delay time.
- To continue supplying power from the inverter during the OFF Delay time, set using the optional "SAN GUARD IV Lite" power supply control software.

Note1: For OUTPUT Control Setting

- When using "SANGUARD IV Lite" or the LAN I/F card, the setting of the software or LAN I/F card has priority over the UPS setting.

12.2.2 Power Outage Beeper Setting

Selects whether the beeper is activated during a power outage.

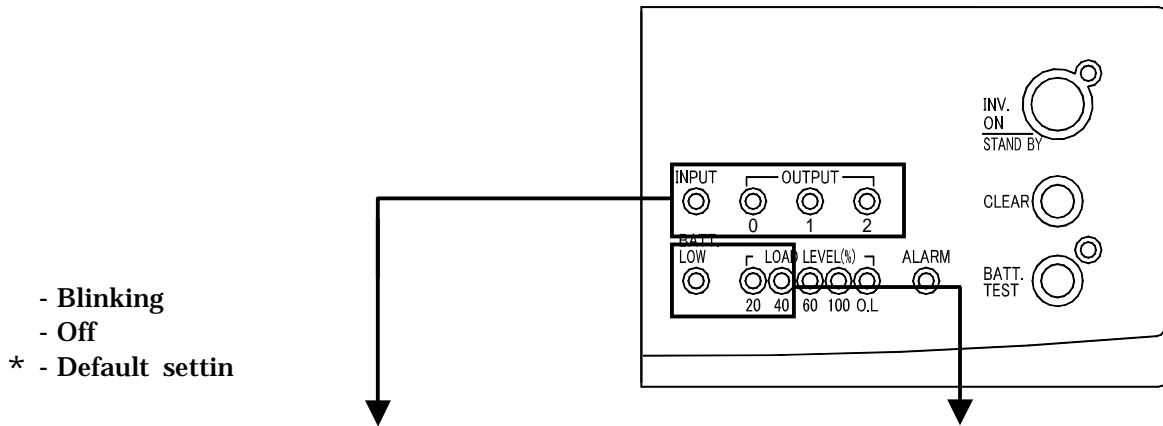

Setting item	Item LED indication	Setting value	Setting value LED indication
Power outage beeper select		Normal sound*	
		Silent	

Restart of the UPS is not required to make setting change effective.

12.2.3 Output Frequency Range Setting

Set the range (%) of acceptable input frequency variation to be tracked by the output frequency. A smaller value provides better precision, but increase the likelihood of switching to battery power if the input frequency is unstable. Select a larger value if the UPS is used with an EG (Engine Generator).

Setting item	Item LED indication	Setting value	Setting value LED indication
Frequency tracking range		1%	
		3%*	
		5%	

Caution

After changing the setting, turn off the MAIN switch for at least one minute to shut down the inverter, and then restart (changes do not take effect until after restart occurs).

12.2.4 OUTPUT 0 Operation After OUTPUT 1 and 2 Shutdown During Power Outage

Sets the type of OUTPUT 0 power backup operation to occur after power to OUTPUT 1 and 2 has been shut down by UPS management software during a power outage. When OUTPUT 0 power backup is set to continue during a power outage, some battery power is necessarily consumed even when no load is connected to the OUTPUT 0 outlets.

Setting item	Item LED indication	Setting value	Setting value LED indication
Operation after UPS output is shut off by power management software (during AC power outage)		Continue OUTPUT 0 supply*	
		Shut down OUTPUT 0	

Restart of the UPS is not required to make setting change effective.

Caution

When this item is set to shut down OUTPUT 0 during a power outage, the UPS will be completely turned off. In this case, data such as scheduled power switching times set by UPS management software are lost, so scheduled startup operations are disabled. To retain this kind of data, select the "Continue OUTPUT 0 supply" setting.

12.2.5 PC Interface Selection

Selects the PC interface. Select the Stand-Alone mode to use the contact-point interface or a standard operating system UPS service, or select the W/S (Workstation) mode to use our optional power management software.

Setting item	Item LED indication	Setting value	Setting value LED indication
PC Interface setting		Stand-Alone mode*	
		W/S mode	
		none	

Caution

After changing the setting, turn off the MAIN switch for at least one minute to shut down the inverter, and then restart (changes do not take effect until after restart occurs).

12.2.6 Communications Baud Rate Selection

Selects the communications baud rate for the PC interface.

Setting item	Item LED indication	Setting value	Setting value LED indication
Communications baud rate		9600*	
		4800	
		2400	

Caution

After changing the setting, turn off the MAIN switch for at least one minute to shut down the inverter, and then restart (changes do not take effect until after restart occurs).

12.2.7 Ring Signal Start Setting

Sets Ring signal start capability. When the Ring signal is enabled, the PC can be started when the UPS starts up.

Setting item	Item LED indication	Setting value	Setting value LED indication
Ring Signal Start		Enabled*	
		Disabled	

Caution

This setting is effective only with PCs that support the Wake Up on Ring feature, and it must also be enabled in the settings on the PC.

After changing the setting, turn off the MAIN switch for at least one minute to shut down the inverter, and then restart (changes do not take effect until after restart occurs).

12.2.8 Battery Starting Frequency

Sets the AC output frequency when starting under battery power.

Setting item	Item LED indication	Setting value	Setting value LED indication
Battery start frequency		50 Hz*	
		60 Hz	

Caution

After changing the setting, turn off the MAIN switch for at least one minute to shut down the inverter, and then restart (changes do not take effect until after restart occurs).

13. Specifications

Item		Specifications/Characteristics		Remarks	
Mode		A11GN102	A11GN152		
Output capacity		1.0 kVA / 0.8 kW	1.5 kVA / 1.2 kW		
Cooling system		Forced air-cooling			
AC input	Number of phases/wires	Single-phase 2-wire			
	Voltage	200,220,230,240 V $\pm 15\%$		Switch selectable (same as output voltage)	
	Frequency	50 or 60 Hz $\pm 1, \pm 3, \pm 5\%$		Tolerance is determined by output frequency accuracy setting (Note 1)	
	Power consumption	1.35 kVA		Maximum consumption during battery recovery charging	
	Input power factor	0.95 or more		At rated output (Note 2)	
AC output	Number of phases	Single phase 2-wire		(Note 3)	
	Voltage	200,220,230,240 V		Switch selectable	
	Voltage setting accuracy	$\pm 2\%$			
	Frequency	50 or 60 Hz		Same as input frequency (automatic selection)	
	Frequency accuracy	Rated frequency within $\pm 3.0\%$ (when synchronized with commercial mains frequency)		1, 3, 5% (switch selectable) Internal oscillator accuracy $\pm 0.5\%$	
	Voltage waveform	Sine wave			
	Voltage waveform distortion	Linear load: 3% or less 100% rectifier load: 7% or less		At rated output	
	Transient voltage tolerance	Rapid load change	Rated voltage within $\pm 5\%$		0 100% change or output change
		Power outage/recovery			At rated output
		Rapid voltage change on input			$\pm 10\%$ change
	Response time	5 cycles or less			
	Load power factor	0.8 (lag)		Variation range 0.8 (lag) to 1.0	
	Overcurrent protection function	Automatically switched to bypass circuit when more than 105%		Auto return function is provided	
Overload handling capacity	Inverter	105%		200ms	
		200%		30 seconds	
		800%		2 cycles	
Battery	Type	Cylindrical nickel-metal hydride battery			
	Rated capacity	6400 mAh			
	Number of batteries	1 battery	2 batteries	battery pack	
	Back-up time	10 minutes	15 minutes	Ambient 25°C, at rated load	
Ambient conditions	Ambient temperature: 0 to 40°C (32 to 104° F) Relative humidity: 30 to 90%		Non condensing (Note 4)		
Audible noise	40 dB or less		1 m from the UPS front panel A characteristic		

Note 1. When AC input frequency is within $\pm 3\%$ (settable to $\pm 1, 3$ or 5%) of the rated frequency, and the AC input voltage is within $\pm 15\%$ of the rated voltage, inverter output is synchronized with the AC input. This makes possible switching of the power source without interruption. If the AC input frequency is outside of this range, battery operation is started.

Note 2. When voltage waveform distortion is less than 1%.

Note 3. If grounded, the ground phase of the input and output must match according to UPS specifications.

Note 4. Because the UPS includes batteries, do not operate it for long periods where the ambient temperature exceeds 30°C. (86° F)

14. Warranty Conditions

The warranty period for this UPS is one full year after purchase. After one year, repair service is available at a charge, subject to the following conditions.

Free Warranty Conditions

1. If the product malfunctions under normal operating conditions as stated in this manual, repair is provided free of charge during the warranty period.
2. If the UPS breaks down, please contact your nearest sales representative.
3. The warranty coverage does not include the following conditions.
 - (1) Defects or damages arising from improper repair, modification or wiring made by the customer.
 - (2) Defects or damages arising from fire, earthquake, rain or water disaster, lightning or other natural disasters including pollution, salt disaster, gas disaster (chloride gas), unusual voltage or incorrect power sources other than those specified.
 - (3) Defects or damages arising from improper handling, such as falling of the UPS during transportation or relocation by the customer after it has been delivered.